



MS/MSS

50Hz/60Hz

Light Stainless Steel Horizontal Single-stage Centrifugal Pump



Nanfang Pump Industry Co.,Ltd.

CNP Headquarter

Address: Renhe Town, Hangzhou, China

Post code: 311107

Tel: +86 571 86051667,86390516,86390517

Fax: +86 571 86051696

E-mail: info@nanfang-pump.com

<http://www.cnppump.com>

E150303
309010100043
subject to amendments



Company Profile



Founded in 1991, Nanfang Pump Industry Co., Ltd. (hereinafter referred to as CNP) has been listed on the Shenzhen Stock Exchange on 9th December 2010; Stock name: CNP; Stock code: 300145.

As the first enterprise specializing in the research and large-scale production of stainless steel stamping welded centrifugal pump in China, CNP is currently the professional manufacturer with the highest volume of production and marketing in that industry. It ranks first in the country in terms of product scope, sales volume, and production quality. The company has set up a complete network of marketing services to meet the requirements of overseas markets as well as domestic needs. The products have seen a wide range of application in the area of pressurization, industry, living water, cycling of air-conditioning water, heat supply, fire extinguishing system, pumping of underground water, treatment of sewage and waste water, chemical industry and desalination of sea water etc.

CNP has now entered into the fast track of development and has taken a major step forward in forging China Strong Pump Enterprise and World's famous brand in the Pump Industry. In order to better meet the client's needs and requirements for expansion, it has set up a wide network of selling and service, as well as offices and service centers in major cities in China, which are aimed at providing timely and effective services for our clients. Meanwhile, our company has successfully penetrated into the world market by forging a good business relationship with more than 50 countries and regions in the Europe, Northern American, and Southeast Asia etc.

Content

General Data

Definition of model	3
Structure features	3
Application	3
Pumping liquids	4
Operating condition	4
Motor	4
Installation requirements	4
Curves	4
Scope of performance	5
Performance table	5
Section drawing	7
Material	7

Technical Data

MS60,50Hz	8
MS100,50Hz	9
MS160,50Hz	10
MS250,50Hz	11
MS330,50Hz	12
MSS100,60Hz	13
MSS160,60Hz	14
MSS250,60Hz	15
MSS330,60Hz	16
Installation sketch	17
Size and weight	17

● Definition of model

MS250/1.5

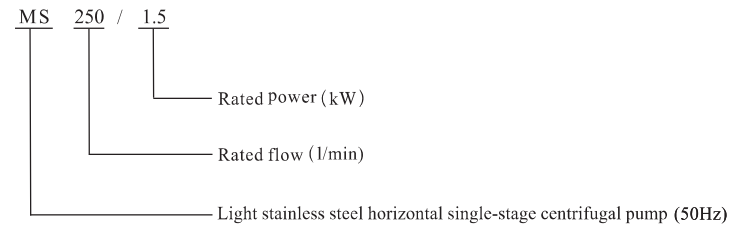

MSS250/1.5

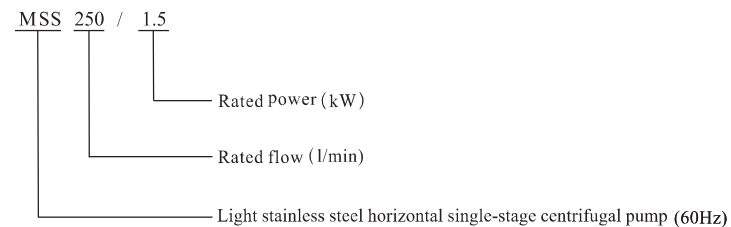

● Structure features

- MS/MSS series of pump is single-stage centrifugal pump and features axial suction and radial discharge;
- Compact structure, the pump is directly connected with the motor, coaxial installation;
- Convenient installation, screw thread water inlet and outlet;
- Light weight, thin plate pressing structure for main parts and components;
- A little corrosion resistance, material of wet parts is AISI 304 or AISI 316 stainless steel.

● Application

- Pressurization and pumping of industrial and civilian clean water or other liquids;
- Water treatment ;
- Water circulating system;
- Agricultural irrigation;
- Other fields.

● Pumping liquids

- Thin, clean, non-flammable and explosive, not containing the liquid with solid particle and fiber;
- Able to transmit light corrosive medium (Relate to the content of chloride ion in the medium, thickness of acid or alkali, whether generate corrosion on the rubber and mechanical seal materials);
- The density of transmitted medium is less than that of clean water, viscosity close to that of water. Other wise the motor of large power is required.

● Operating condition

- Liquid temperature $-10^{\circ}\text{C} \sim +85^{\circ}\text{C}$;
- Ambient temperature: up to $+40^{\circ}\text{C}$;
- Altitude: up to 1000m;
- Max. pressure of the system is 8bar.

● Motor

- TEFC motor, 2-pole;
- Protection class: IP55;
- Insulation class :F;
- Standard voltage: 50Hz $1 \times 220\text{V}$
 $3 \times 380\text{V}/3 \times 220\text{V}$
- Standard voltage: 60Hz $1 \times 220\text{V}$
 $3 \times 380\text{V}/3 \times 220\text{V}$

● Installation requirements

- The pump shall be fastened on the stable horizontal base;
- The installation of the pump shall ensure that the pump will not be influenced by the tension of the pipeline;
- The pump shall be installed on the ventilating and anti-freezing place to ensure normal operation of the motor;
- Electric wiring device shall guarantee that the pump will not be damaged by lack of phase, unstable voltage, current leakage and overload.

● Curves

Include performance curve in the technical data:

- All curves are based on the measured values of 50Hz: constant motor speed 2850r/min, 60 Hz: constant motor speed 3450r/min.
- Measurement is done with 20°C air-free water, kinematic viscosity of $1\text{mm}^2/\text{sec}$.
- Curve tolerance in conformity to ISO9906:2012 Grade 3B.
- The operation of pump shall refer to the performance region to prevent overload of motor due to too large flow rate.

● Scope of performance-50Hz

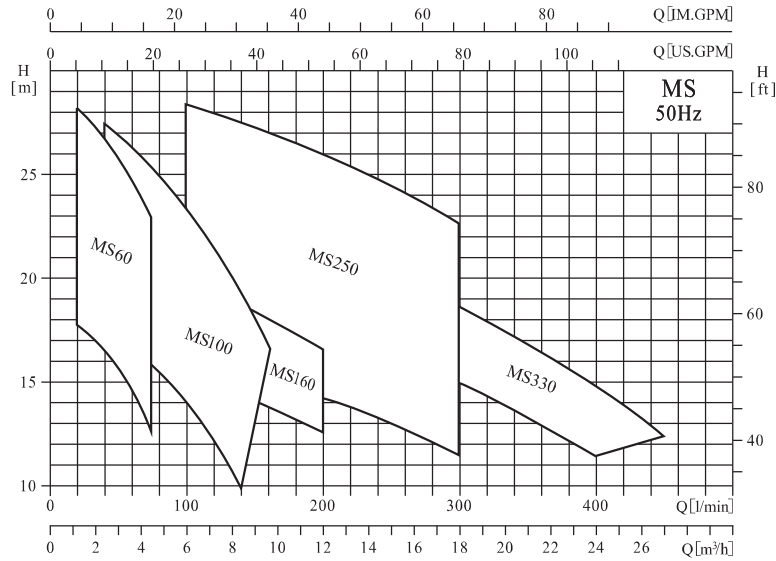

● Scope of performance-60Hz

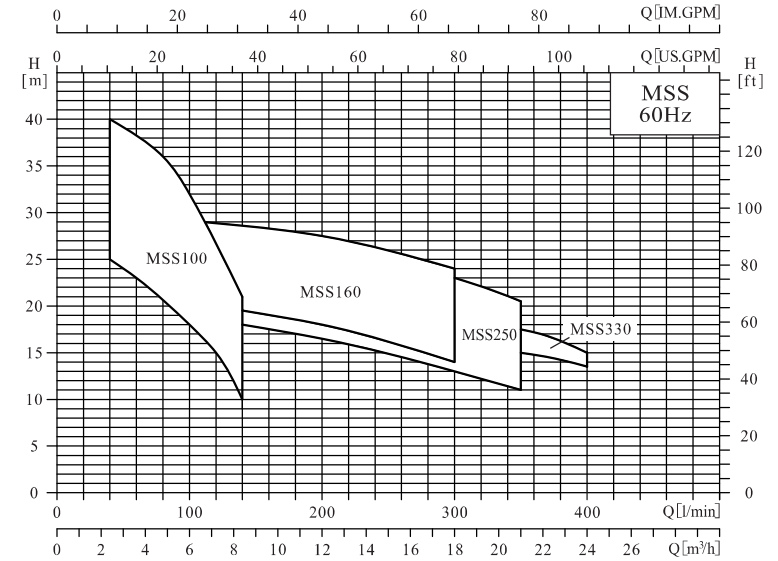

● Performance table

Model	Driving motor		Q(l/min)	Q(m³/h)															
	(kW)	(hp)		20	40	60	80	100	120	140	160	200	250	300	330	350	400	450	
MS60/0.37	0.37	0.5		17.7	16.4	14.6	11.4												
MS60/0.55	0.55	0.75		22.7	21.3	19.5	16.2												
MS60/0.75	0.75	1		28.2	26.8	25	22												
MS100/0.55	0.55	0.75	H (m)	17.8	16.7	15.4	14	12.2	9.9										
MS100/1.1	1.1	1.5		27.4	26.3	25	23.4	21.5	19.5	16.7									
MS160/0.75	0.75	1			15.5	15.3	15	14.8	14.3	13.8	12.5								
MS160/1.1	1.1	1.5			19.7	19.5	19.3	19.1	18.7	18.2	16.5								
MS250/1.1	1.1	1.5						15.8	15.6	15.4	15	14.3	13	11.5					
MS250/1.5	1.5	2						23.2	23	22.7	22.2	21.4	19.8	17.7					
MS250/2.2	2.2	3						28.2	27.8	27.5	27	26.2	24.6	22.6					
MS330/1.5	1.5	2						18.8	18.7	18.5	17.8	16.7	15	14	13.5	11.6			
MS330/2.2	2.2	3						22.5	22.2	22	21.5	20.3	18.7	17.5	16.8	14.8	12.3		

● Performance table

Model	Driving motor		Q(l/min)	Q(m³/h)															
	(kW)	(hp)		20	40	60	80	100	120	140	160	200	250	300	330	350	400		
MSS100/0.75	0.75	1		25	23	21	17	15	10										
MSS100/1.1	1.1	1.5		33	31	29	25	21	15										
MSS100/1.5	1.5	2		40	38	36	32	27	22										
MSS160/1.1	1.1	1.5	H (m)				20.5	20	19.5	19	18	17	14						
MSS160/1.5	1.5	2					25.5	25	24.5	24	23	22	20						
MSS160/2.2	2.2	3					29	28.8	28.5	28	27.5	26	24						
MSS250/1.1	1.1	1.5						18.5	18	17.5	16.5	15	13	12	11				
MSS250/1.5	1.5	2						22.5	22	21.5	20.5	18.5	16	14	13				
MSS250/2.2	2.2	3						28.5	28	27.5	26.5	25	23	21.5	20.5				
MSS330/1.5	1.5	2									19.5	19	18.5	18	16.5	16	15	13.5	
MSS330/2.2	2.2	3									23	22.5	22	20.5	19.5	18.5	17.5	15	

Section drawing

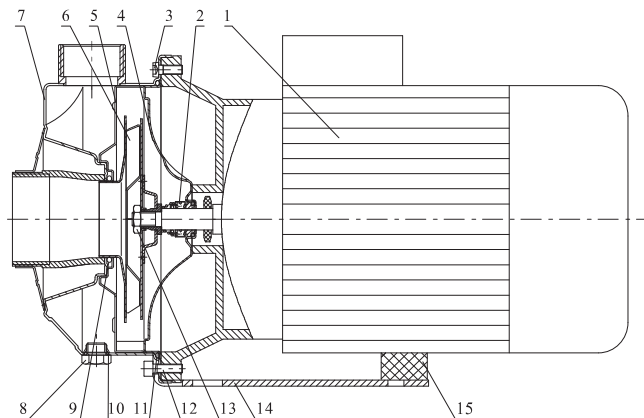

Material

NO.	Parts Name	Material	AISI
1	Motor		
2	Mechanical seal	Carbon / Silicon Carbide	
3	M6 x 15 / Screw	06Cr19Ni10/SS304	AISI304
4	Seal base	06Cr19Ni10/SS304	AISI304
5	Diffuser	06Cr19Ni10/SS304	AISI304
6	Impeller	06Cr19Ni10/SS304	AISI304
7	Pump body	06Cr19Ni10/SS304	AISI304
8	Vent	06Cr19Ni10/SS304	AISI304
9	O-Ring	NBR	
10	O-Ring	NBR	
11	O-Ring	NBR	
12	M6 x 20 / Screw	06Cr19Ni10/SS304	AISI304
13	Nut M10	06Cr19Ni10/SS304	AISI304
14	Base	Steel	A570
15	Support foot	NBR	

Performance curve

ISO9906 Annex A

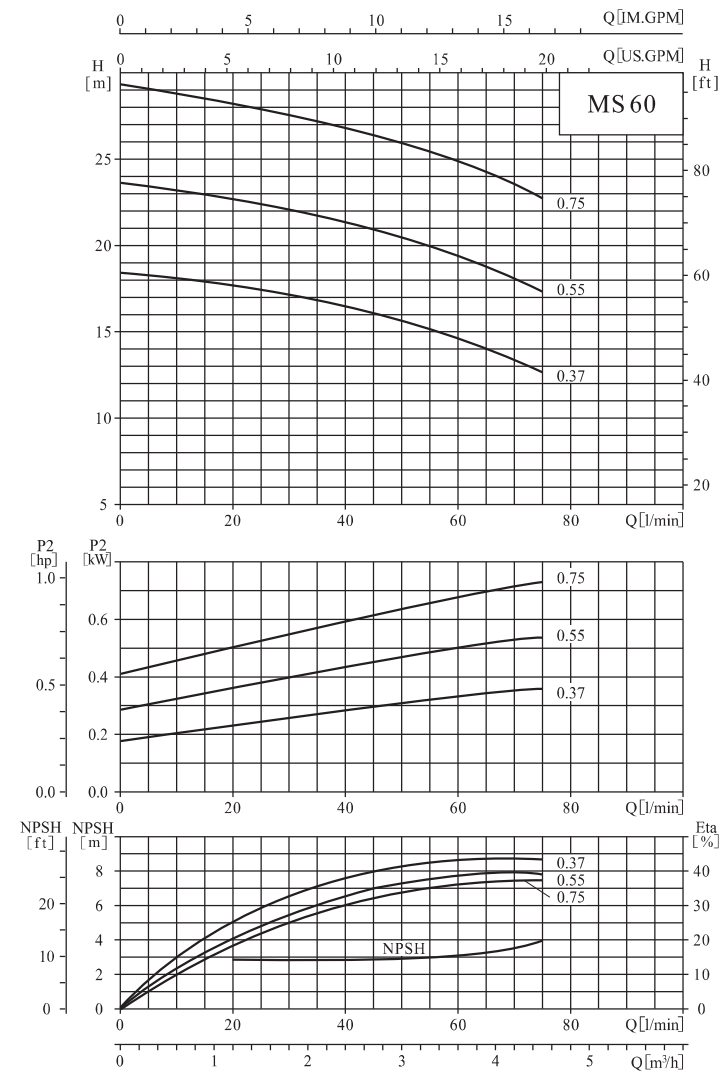

● Performance curve

ISO9906 Annex A

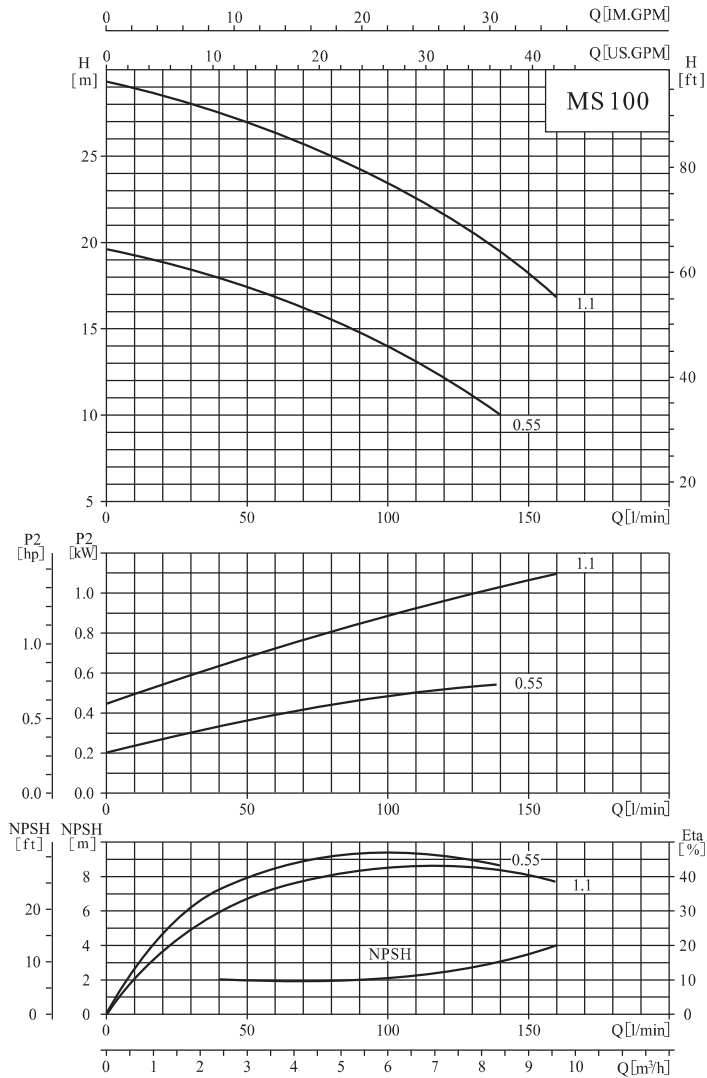

● Performance curve

ISO9906 Annex A

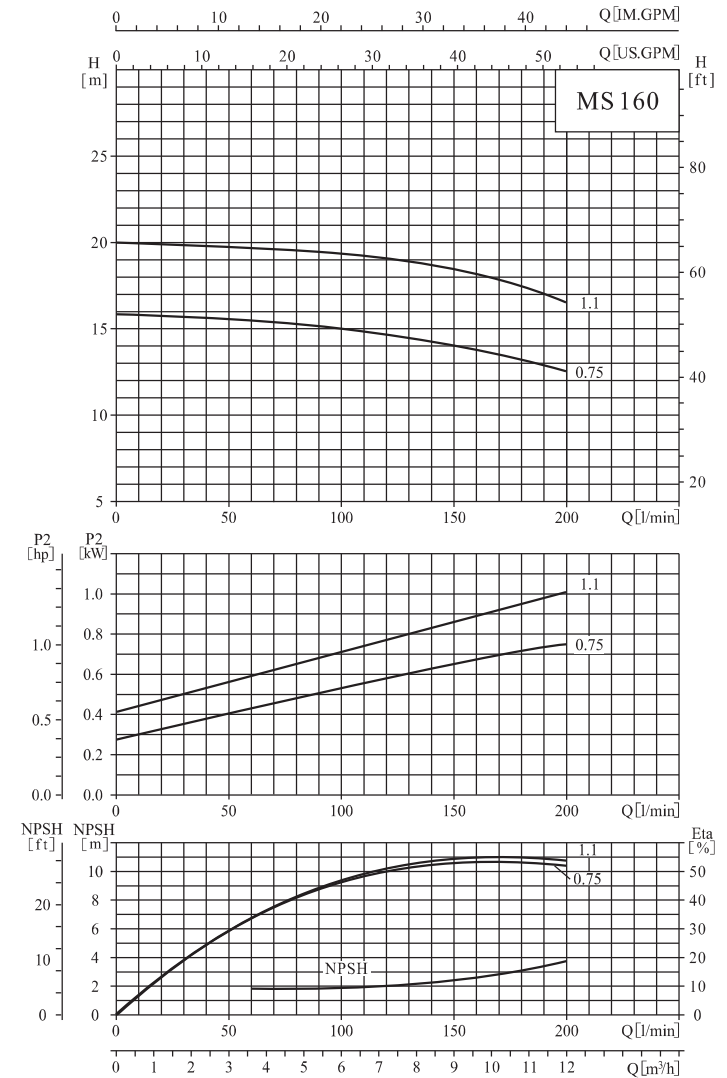

● Performance curve

ISO9906 Annex A

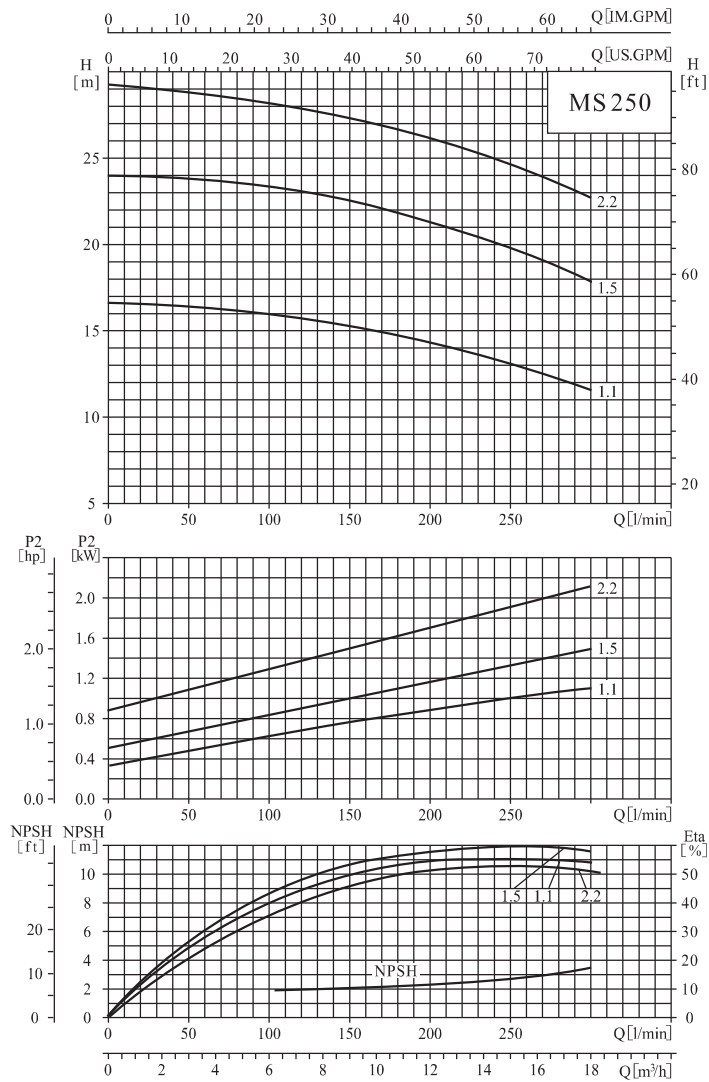

● Performance curve

ISO9906 Annex A

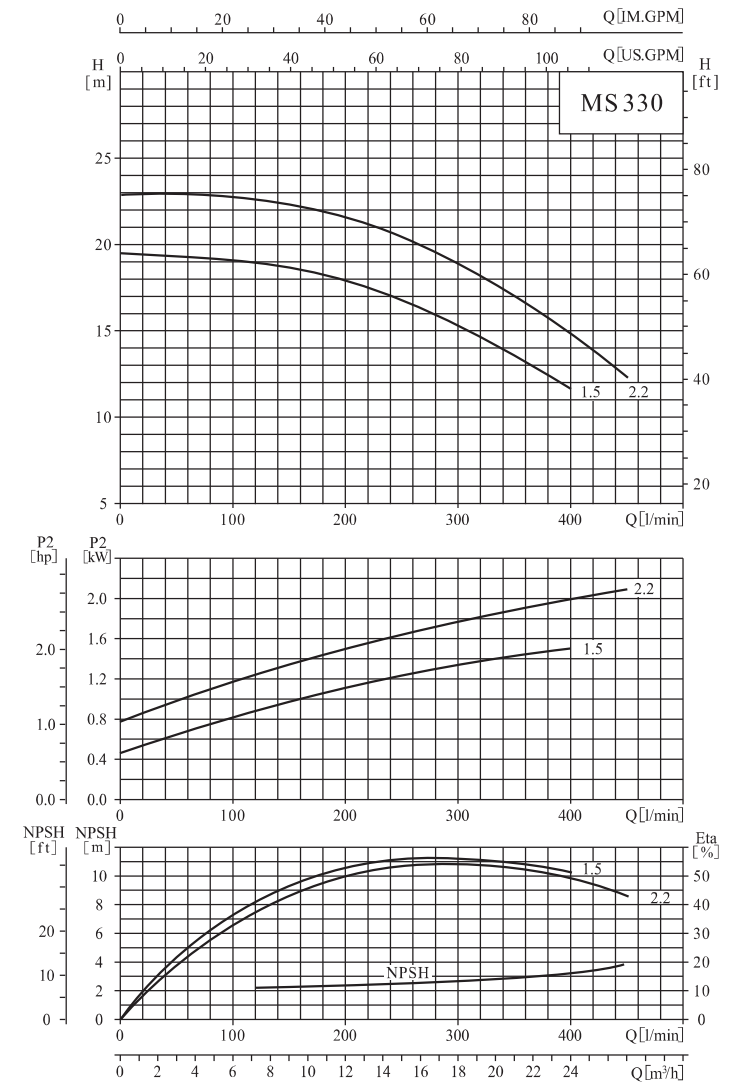

● Performance curve

ISO9906 Annex A

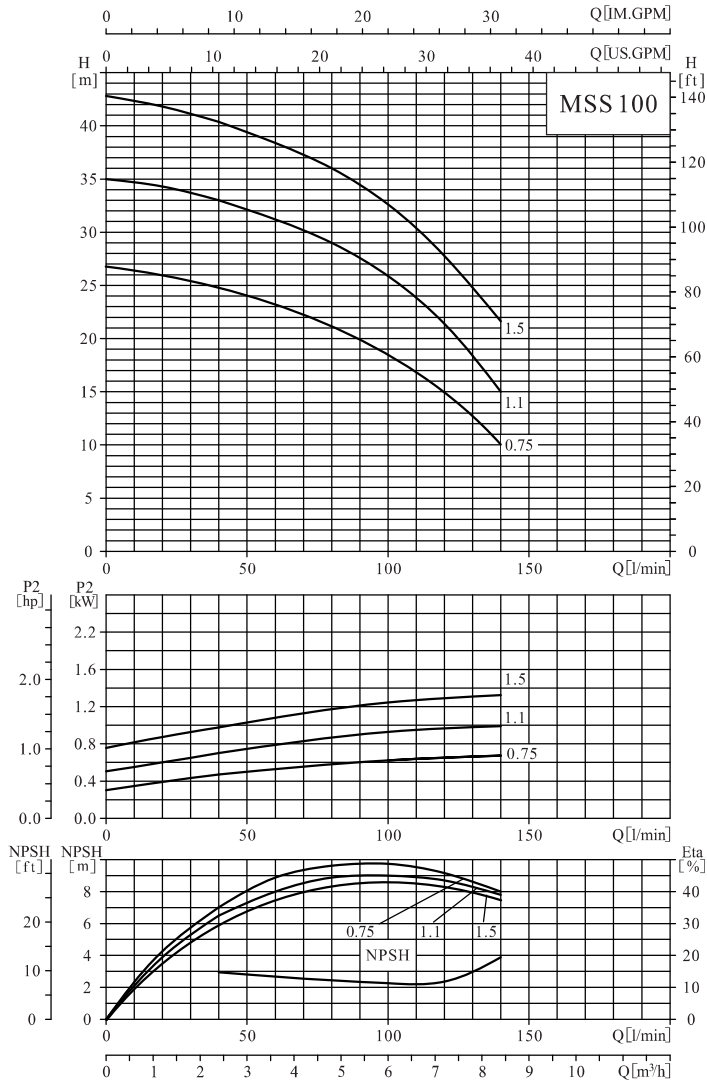

● Performance curve

ISO9906 Annex A

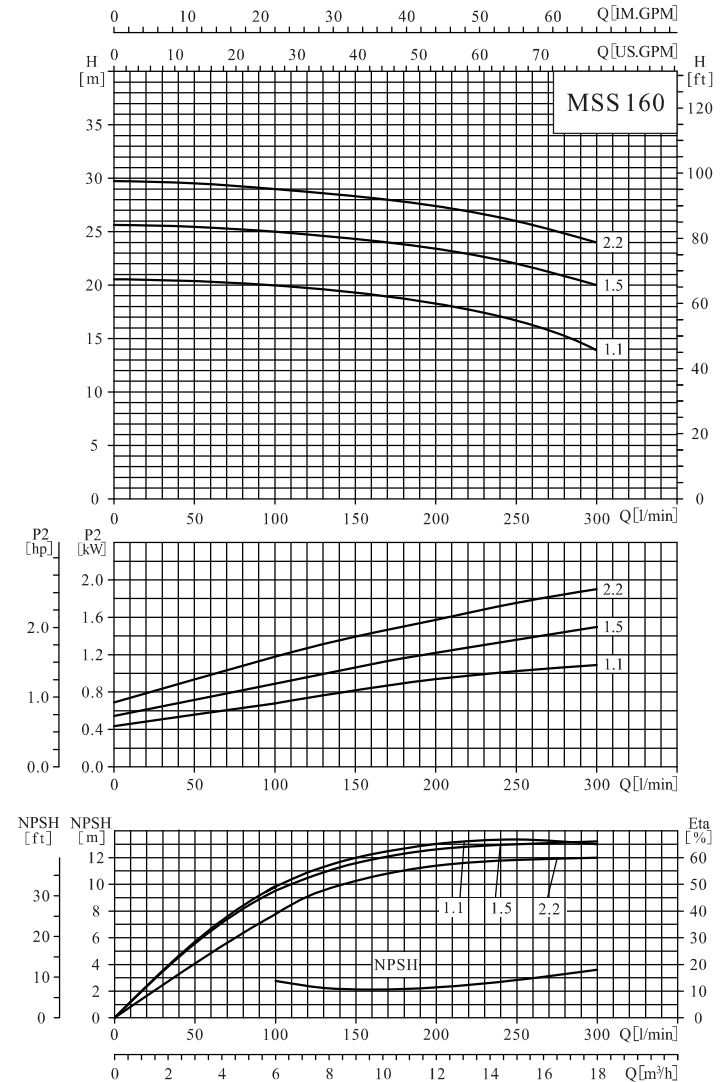

● Performance curve

ISO9906 Annex A

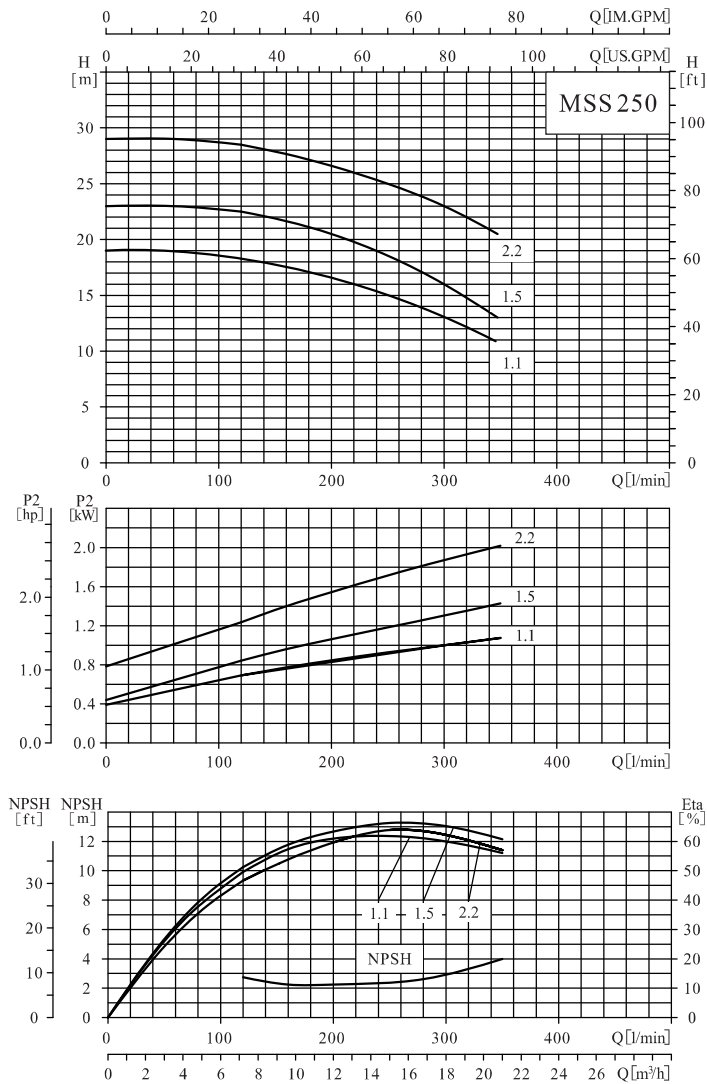

● Performance curve

ISO9906 Annex A

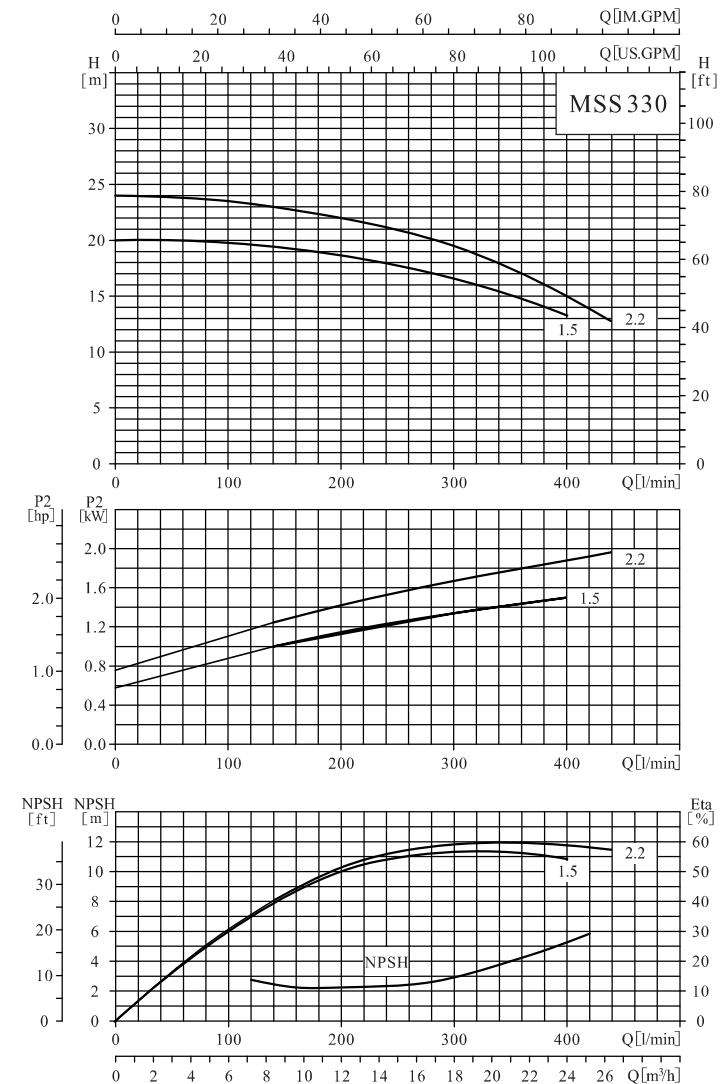

● Installation sketch

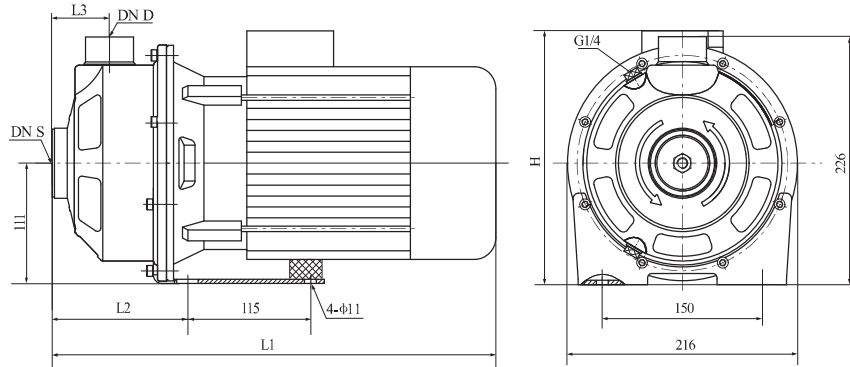

● Size and weight-50Hz

Model	Motor			L1	L2	L3	H	DN S	DN D	Weight
	Phase	kW	hp							
MS60/0.37	3PH/1PH	0.37	0.5	328	113	51	216 / 230	G1 $\frac{1}{4}$	G1	10
MS60/0.55		0.55	0.75	328	113	51	216 / 230	G1 $\frac{1}{4}$	G1	12
MS60/0.75		0.75	1	361	113	51	223 / 245	G1 $\frac{1}{4}$	G1	14
MS100/0.55		0.55	0.75	328	113	51	216 / 230	G1 $\frac{1}{4}$	G1	12
MS100/1.1		1.1	1.5	361	113	51	223 / 245	G1 $\frac{1}{4}$	G1	16
MS160/0.75		0.75	1	375	127	54	223 / 245	G1 $\frac{1}{2}$	G1 $\frac{1}{4}$	14
MS160/1.1		1.1	1.5	375	127	54	223 / 245	G1 $\frac{1}{2}$	G1 $\frac{1}{4}$	16
MS250/1.1		1.1	1.5	375	127	54	223 / 245	G1 $\frac{1}{2}$	G1 $\frac{1}{4}$	16
MS250/1.5		1.5	2	415	127	54	232 / 253	G1 $\frac{1}{2}$	G1 $\frac{1}{4}$	20
MS250/2.2		2.2	3	415	127	54	232 / 253	G1 $\frac{1}{2}$	G1 $\frac{1}{4}$	23
MS330/1.5		1.5	2	415	127	54	232 / 253	G2	G1 $\frac{1}{4}$	20
MS330/2.2		2.2	3	415	127	54	232 / 253	G2	G1 $\frac{1}{4}$	23

● Size and weight-60Hz

Model	Motor			L1	L2	L3	H	DN S	DN D	Weight
	Phase	kW	hp							
MSS100/0.75	3PH/1PH	0.75	1	361	113	51	223 / 245	G1 $\frac{1}{4}$	G1	14
MSS100/1.1		1.1	1.5	361	113	51	223 / 245	G1 $\frac{1}{4}$	G1	14
MSS100/1.5		1.5	2	401	113	51	232 / 253	G1 $\frac{1}{4}$	G1	20
MSS160/1.1		1.1	1.5	375	127	54	223 / 245	G1 $\frac{1}{2}$	G1 $\frac{1}{4}$	16
MSS160/1.5		1.5	2	415	127	54	232 / 253	G1 $\frac{1}{2}$	G1 $\frac{1}{4}$	20
MSS160/2.2		2.2	3	415	127	54	232 / 253	G1 $\frac{1}{2}$	G1 $\frac{1}{4}$	23
MSS250/1.1		1.1	1.5	375	127	54	223 / 245	G1 $\frac{1}{2}$	G1 $\frac{1}{4}$	16
MSS250/1.5		1.5	2	415	127	54	232 / 253	G1 $\frac{1}{2}$	G1 $\frac{1}{4}$	20
MSS250/2.2		2.2	3	415	127	54	232 / 253	G1 $\frac{1}{2}$	G1 $\frac{1}{4}$	23
MSS330/1.5		1.5	2	415	127	54	232 / 253	G2	G1 $\frac{1}{4}$	20
MSS330/2.2		2.2	3	415	127	54	232 / 253	G2	G1 $\frac{1}{4}$	23

MEMO

A series of horizontal dashed lines for writing.

MEMO

A series of horizontal dashed lines for writing.

